

SRM-121/150GS

12.1"/15" Sunlight Readable
TFT LCD Monitor



- Super High Brightness
- Auto-Dimming
- Anti-Reflection
- Wide Temperature
- IP65

Features

- 800 and 1000nits super high brightness
- 12.1" Anti-Reflection Technology
- Nature Color Matrix (NCM) Technology
- Innovative auto-dimming function
- Wide Operating Temperature: -10°C~+60°C
- IP 65 Compliant



With Auto-Dimming Function

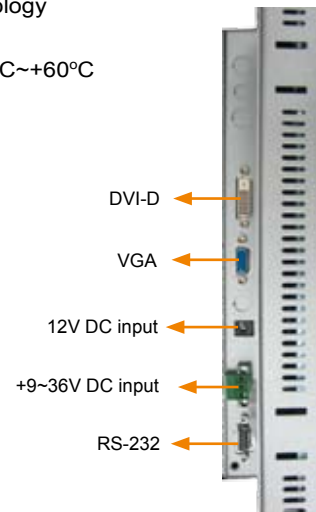

Specifications

Model	SRM-121GS	SRM-150GS
LCD Size	12.1"	15"
Resolution (H x V)	800 x 600 (SVGA)	1024 x 768 (XGA)
Luminance (cd/m ²)	1000	800
Contrast Ratio	700:1	600:1
Display Color	262k	262k
View Angle (U/D/R/L)	45°/75°/60°/60°	65°/50°/75°/75°
Pixel Pitch (mm)	0.3075	0.297
Operating Temperature	-10°C ~ +60°C	
Storage Temperature	-20°C ~ +70°C	
Lamp Life Time	50000hrs	
Input Interface	Analog VGA , DVI-D	
Front Frame	Aluminum	
Chassis	Heavy-duty Steel	
OSD Function	Yes	
Power Input	+12VDC/+ 9 ~ +36VDC(optional)	
Mounting	Wall/Panel/Rack/Arm/Stand	
Front Panel Protection	IP65 Compliant	
Net Weight	3.3kgs	6kgs
Dimension (W x H x D mm)	340 x 260 x 58	410 x 309 x 65.2

Super High Brightness

Typical high brightness monitors usually have more than six CCFLs, but the IEI SRM monitors have super high brightness with only four CCFLs. IEI SRM panels are still readable in bright sunlight with fewer backlights and thereby not increasing power consumption or producing extra heat.

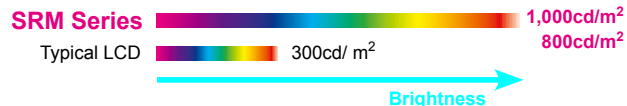

Wide Temperature Range

Extended IEI environment testing is performed to ensure the SRM series continue to function properly over its entire services life in a wide working temperature range of -10°C to +60°C in order to accommodate a diverse industrial applications such as outdoor kiosks in winter and summer.

Conventional Operation: 0°C~50°C



Low Reflection through Anti-Reflection Technology

Outdoor applications in daylight or other bright environments require technology that can suppress surface reflection. The SRM series has special AR (anti-reflection) surface treatment to prevent reflection, ensuring excellent visibility in daylight conditions.



How does Anti-Reflection Surface work?



Dimensions

SRM-121GS

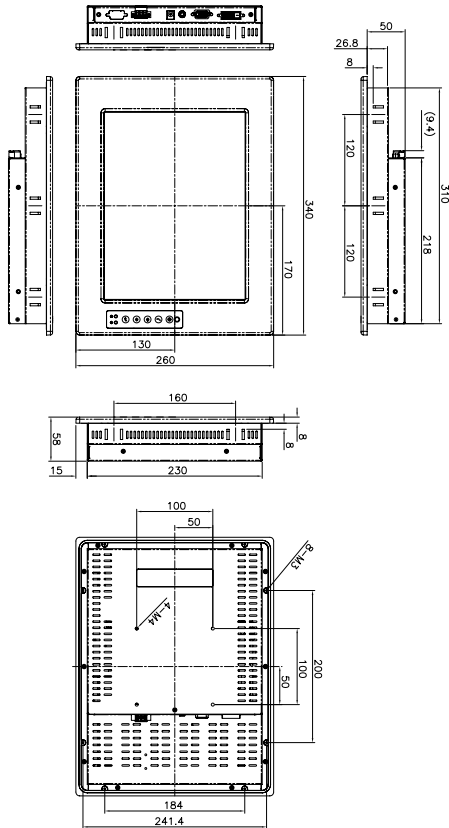

SRM-150GS

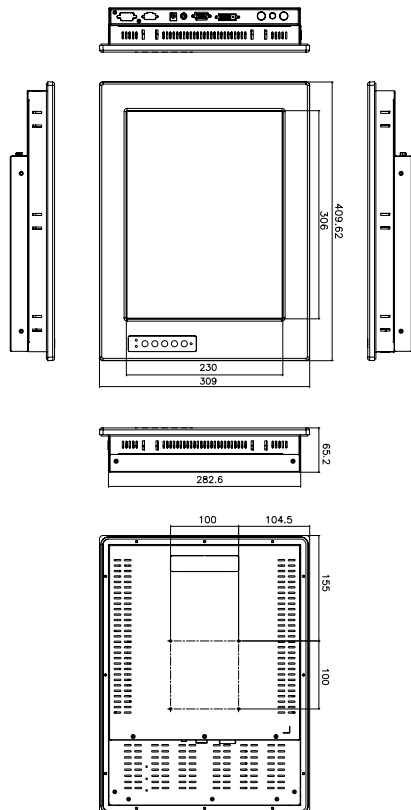

Natural Color Matrix (NCM) Technology

POS terminals and kiosks often display advertisements and colorful images, the colors of which must remain vivid and faithful to the original. The IEI SRM monitor with NCM optimization technology prevents this difference by separating color data and luminance components while controlling individual display colors for optimized performance.

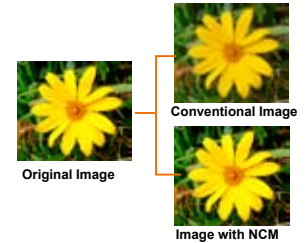
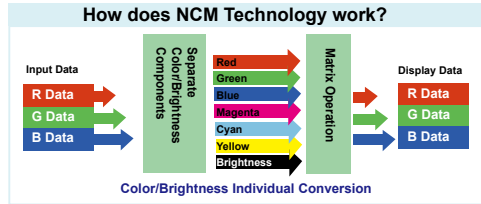

Innovative Auto-Dimming Function

IEI SRM series with auto-dimming function can adjust brightness according to ambient light, so that SRM series can job properly under different lamp house average, and outdoor environment. This function not only saves unnecessary brightness that strains eyes strained and makes you tire but also saves energy saving.

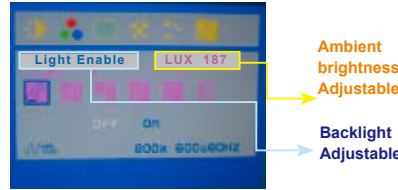

The SRM series with new manual auto-dimming setting function can automatically adjust the backlight and ambient brightness default setting value to meet your preference in any environment.



Mounting Kits Information

	SRM-121GS	SRM-150GS
Panel Mount Kit	Pk-121M	Pk-150M
Wall Mount Kit	Wk-121MS-R10	Wk-150MS-R10
Rack Mount Kit	RK-121MS-R10	RK-150MS-R10
LCD Monitor Arm	Arm-11	Arm-31
LCD Monitor Stand	STAND-100-RS	STAND-100-RS

Packing List

1 X AC Power Cable	1 X User Manual-CD ROM
1 X VGA Cable	1 X Power Cable for Terminal Block (For M model only)
1 X DVI cable	1 X Touch Screen RS-232 Cable / Touch Pen / Driver CD ROM (For T-R model only)
1 X 45W AC Power Adapter	1 X Touch Screen USB Cable / Touch Pen / Driver CD ROM (For USB / T-R model only)
1 X Screw set	

Ordering Information

SRM-121GS

SRM-121GS	12.1" 1000cd/m ² Sun Readable LCD Monitor, Aluminum Front Panel, Silver Color, w/VGA and DVI-D input RoHS
SRM-121GS/T-R	12.1" 1000cd/m ² Sun Readable LCD Monitor, Aluminum Front Panel, Silver Color, w/VGA and DVI-D input , w/12.1" Touch Screen, RoHS
SRM-121GS-USB/T-R	12.1" 1000cd/m ² Sun Readable LCD Monitor, Aluminum Front Panel, Silver Color, w/VGA and DVI-D input , w/12.1" USB Touch Screen, RoHS
SRM-121GMS	12.1" 1000cd/m ² Sun Readable LCD Monitor, Aluminum Front Panel, Silver Color, w/VGA and DVI-D input , w/9~36V DC input , RoHS
SRM-121GMS/T-R	12.1" 1000cd/m ² Sun Readable LCD Monitor, Aluminum Front Panel, Silver Color, w/VGA and DVI-D input , w/9~36V DC input , w/12.1" Touch Screen, RoHS
SRM-121GMS-USB/T-R	12.1" 1000cd/m ² Sun Readable LCD Monitor, Aluminum Front Panel, Silver Color, w/VGA and DVI-D input , w/9~36V DC input , w/12.1" USB Touch Screen, RoHS

SRM-150GS

SRM-150GS	15" 800cd/m ² Sun Readable LCD Monitor, Aluminum Front Panel, Silver Color, w/VGA and DVI-D input RoHS
SRM-150GS/T-R	15" 800cd/m ² Sun Readable LCD Monitor, Aluminum Front Panel, Silver Color, w/VGA and DVI-D input , w/12.1" Touch Screen, RoHS
SRM-150GS-USB/T-R	15" 800cd/m ² Sun Readable LCD Monitor, Aluminum Front Panel, Silver Color, w/VGA and DVI-D input , w/12.1" USB Touch Screen, RoHS
SRM-150GMS	15" 800cd/m ² Sun Readable LCD Monitor, Aluminum Front Panel, Silver Color, w/VGA and DVI-D input , w/9~36V DC input , RoHS
SRM-150GMS/T-R	15" 800cd/m ² Sun Readable LCD Monitor, Aluminum Front Panel, Silver Color, w/VGA and DVI-D input , w/9~36V DC input , w/12.1" Touch Screen, RoHS
SRM-150GMS-USB/T-R	15" 800cd/m ² Sun Readable LCD Monitor, Aluminum Front Panel, Silver Color,