

uIBX-250-BW

Ultra Compact Size



New

Features

- Fanless system with Intel® Celeron® N3160 processor
- Dual display
- Two RS-232/422/485
- Full-size PCIe Mini slot for expansion
- Four USB 3.0 ports
- Two GbE LAN ports



Smart Mounting Design

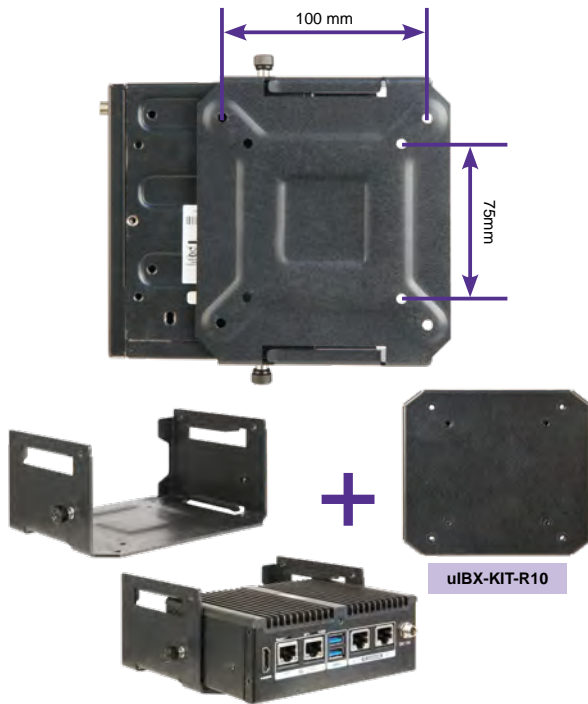

A. Wall mount

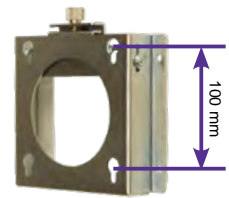

Assemble the uIBX-250 with the uIBX-KIT-R10 on the back of monitor.

AFLWK-12/AFLWK-19

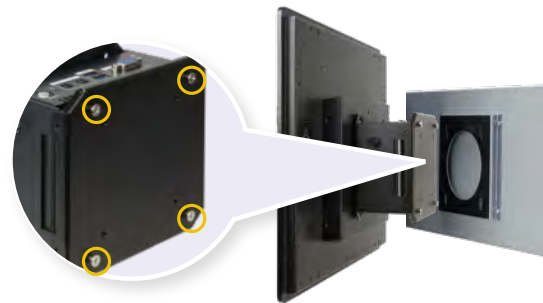

The monitor with the uIBX-250 can be mounted on the wall easily and support VESA 75/100.

B. VESA mount 75/100

Step.1



Install the uIBX-KIT-R10 which supports VESA 75/100 on the back of the monitor.

Step.2



Assemble the uIBX-250, stand and monitor.

Step.3

screw to fix uIBX-250

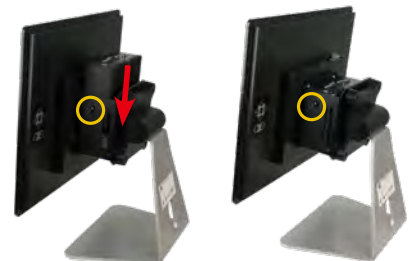

Mount it on the back of monitor to save even more space, the location the uIBX-250 could be adjusted by user for different applications.

Specifications

Model Name		uIBX-250-BW
Chassis	Color	Black
	Dimensions (WxDxH) (mm)	136.6 x 102.4 x 52
	System Fan	Fanless
	Chassis Construction	Extruded aluminum alloy
Motherboard	CPU	Intel® Celeron® N3160 (up to 2.24 GHz, quad-core, 2 MB cache, TDP=6W)
	Chipset	SoC
	System Memory	1 x 204-pin DDR3L SO-DIMM slot (2 GB pre-installed, system max: 8GB)
Storage	Hard Drive	1 x 2.5" SATA 6Gb/s HDD/SSD bay
I/O Interfaces	USB 3.0	4
	Ethernet	2 x RJ-45 PCIe GbE by Intel® I211 controller
	COM Port	2 x RS-232/422/485 (RJ-45)
	Button	1 x Power button, 1 x AT/ATX switch, 1 x Reset button
	Display	1 x HDMI, 1 x VGA
	Resolution	HDMI: 3840 x 2160@30MHz, VGA: 1920 x 1200@60Hz
	Audio	1 x Line-out, 1 x Line-in
	Wireless	1x 802.11a/b/g/n/ac (optional)
Expansions	PCIe Mini	1 x Full-size PCIe Mini (support mSATA, colay with SATA)*
Power	Power Input	DC Jack: 12 V DC
	Power Consumption	12V @ 2A (Intel® Celeron® N3160 with 2 GB memory)
Reliability	Mounting	Wall mount, VESA 75
	Operating Temperature	-20°C ~60°C with air flow (SSD), 10% ~ 95%, non-condensing
	Operating Shock	Half-sine wave shock 5G, 11ms, 3 shocks per axis
	Operating Vibration	MIL-STD-810F 514.5 C-1 (HDD), MIL-STD-810F 514.5 C-2 (SSD)
	Weight (Net/Gross)	470 g/1.4 kg
	Safety/EMC	CE/FCC
OS	Supported OS	Microsoft® Windows 8, Microsoft® Embedded Standard 7 E

*uIBX-250-BW-QGW-R10 has no PCIe mini slot

Dimensions (Unit: mm)

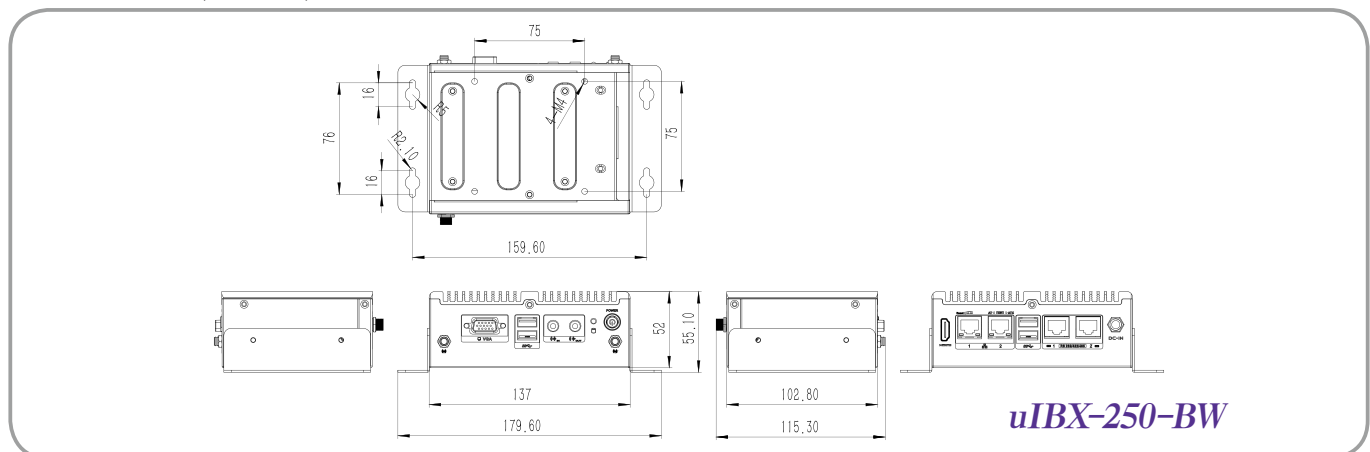

Ordering Information

Part No.	Description
uIBX-250-BW-N3/2G-R20	Fanless embedded system with Intel® Celeron® N3160 1.6 GHz (up to 2.24 GHz, quad core, TDP 6 W), 2 GB DDR3L pre-installed memory, 12V DC, with RS-232/422/485, USB 3.0, VGA/HDMI, dual Intel® PCIe GbE, RoHS
uIBX-250-BW-QGW-R10	Fanless embedded system with Intel® Celeron® N3160 1.6 GHz (up to 2.24 GHz, quad core, TDP 6 W), 4 GB DDR3L pre-installed memory, 12V DC, with RS-232/422/485, USB 3.0, VGA/HDMI, dual Intel® PCIe GbE, with QTS-Gateway, RoHS

Options

Part No.	Description
EMB-WIFI-KIT01-R20	1T1R wifi module kit for embedded system, IEEE802.11a/b/g/n/ac WiFi with Bluetooth 4.0/3.0+HS, 1 x wifi module, 2 x 250mm RF cable, 2 x Antenna, RoHS
DK-75-R10	VESA 75 to DIN-Rail mounting kit
uIBX-KIT-R10	uIBX smart mounting kit for monitor and stand
uIBX-250-BW-WES7E64-R10	OS image with Windows® Embedded Standard 7 E 64-bit for uIBX-250, DVD-ROM, RoHS

Packing List

1 x Power Adapter	1 x Mounting Bracket	2x RS-232/422/485 round cable
-------------------	----------------------	-------------------------------