

ISC-4110U / 8110U



ISC-4110U



ISC-8110U

➤ Industrial 1-port USB to 4/8-port RS-232 serial media converter

Features

- Fully compliant with USB 2.0 specifications
- Support Full-Duplex transmission
- RS-232 support RTS/CTS, DSR/DTR handshake signals
- Support baud rate up to 921.6Kbps
- USB bus powered with Ultra low power consumption (<500mA)
- Rigid IP-30 slim type housing design
- DIN-Rail and wall mounting enabled
- Driver support : Windows/ Win-CE/ Windows Mobile/ Linux multi O.S.



Introduction

ISC-4110U and ISC-8110U are intelligent and compact-size media converters that provide conversion between one Universal Serial Bus (USB) port and 4 or 8 High-Speed RS-232 serial ports. The ISC-4110U and ISC-8110U feature easy connectivity for traditional serial devices. The RS-232 standard supports full-duplex communication and handshaking signals (such as RTS, CTS, DSR, DTR). Internal high-speed transient suppressors on each data line protect the modules from dangerous voltages levels or spikes. ISC-4110U/8110U can derive the power from USB port or redundant power inputs. Therefore, ISC-4110U and ISC-8110U are among the most reliable choices for USB to RS-232 media converter applications.



Connections of USB to Serial Media Converter



Connections of USB to Serial Media Converter

Dimensions

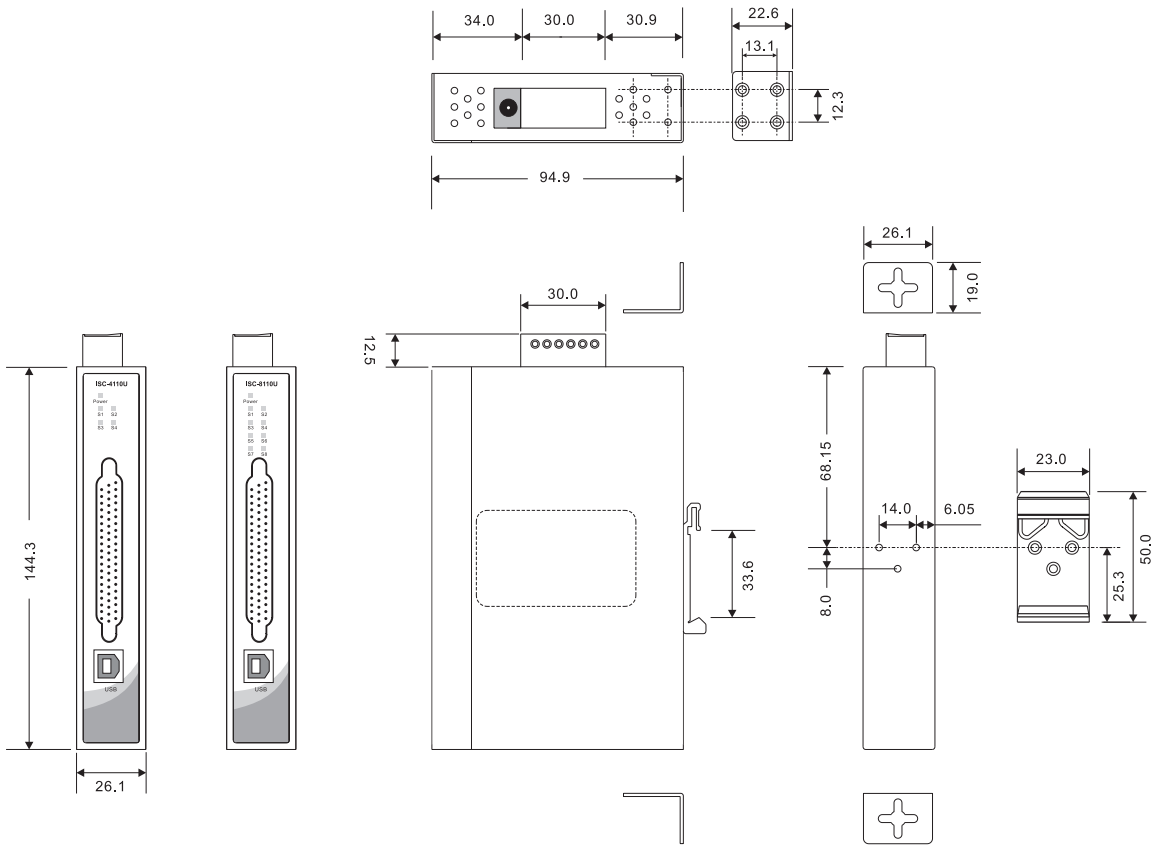

(Unit=mm)

Pin Definitions

Cable of DB62 male to 4/8-port DB9 male connector is provided. The cable length is 1 meter.

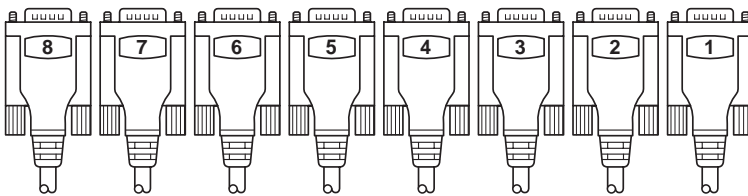

8-port DB9 Male connector

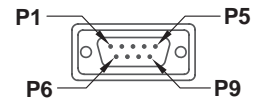

DB9 Male Pin Assignment

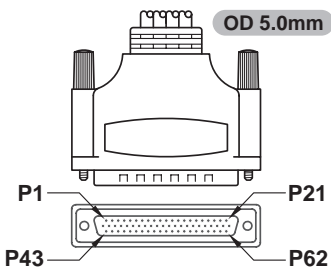

DB62 Male with 4/8-port RS-232 connector

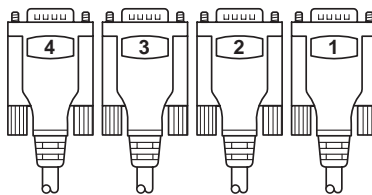

4-port DB9 Male connector

Pin #	RS-232
1	DCD
2	RXD
3	TXD
4	DTR
5	GND
6	DSR
7	RTS
8	CTS
9	N.C.
RS-232 mode act as DTE	

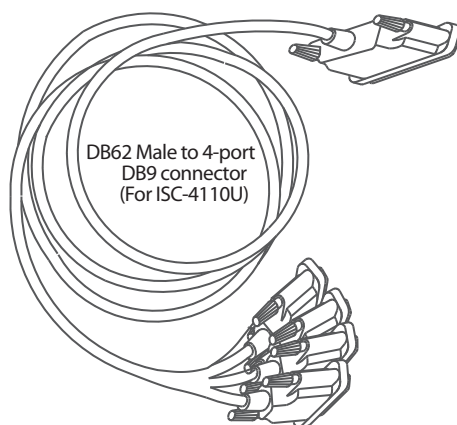
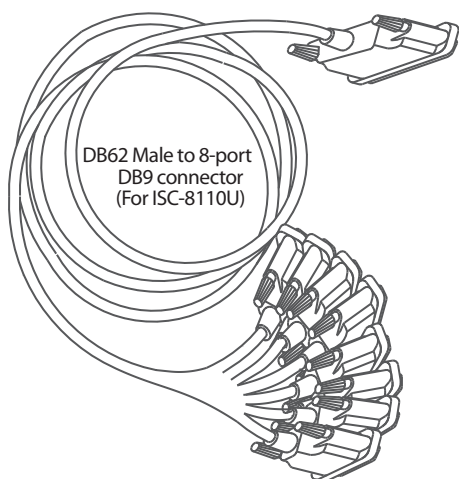

Specifications

ORing Media Converter Model	ISC-4110U	ISC-8110U
Physical Ports		
USB 2.0 port	1	1
RS-232 Serial Port	4	8
Serial Connector	DB9 connector (Male) : By DB62 to 4xDB9 cable	DB9 connector (Male) : By DB62 to 8xDB9 cable
Baud Rate	300 to 921.6Kbps	
RS-232 Signals	TxD, RxD, RTS, CTS, DTR, DSR, DCD, GND	
LED Indicators		
Power Indicator	Green : Power LED x 1	
Data Transmission Indicator	Green LED x 4	Green LED x 8
Power		
Input Power	USB bus power (self power) or Dual DC inputs by 12-48VDC on 2-pin terminal block and power jack	
Power Consumption (Typ.)	1.6 Watts (320mA@5V USB Bus Power)	2 Watts (400mA@5V USB Bus Power)
Protection		
Serial Port Protection	Build-in 15KV ESD protection	
Driver Support		
Operation System	Windows 2000 (32bit), Windows 2000/XP/Vista/2008/7 (32/64bit), Windows Mobile 5/6, PocketPC 2003, WinCE 4.2~5.2/6.0, Linux x86 (32/64bit)	
Physical Characteristics		
Enclosure	IP-30	
Dimensions (W x D x H)	26.1(W) x 94.9(D) x 144.3(H) mm (1.03 x 3.74 x 5.68 inch)	
Weight (g)	348g	350g
Environmental		
Storage Temperature	-40 to 85°C (-40 to 185°F)	
Operating Temperature	-40 to 70°C (-40 to 158°F)	
Operating Humidity	5% to 95% Non-condensing	

Regulatory Approvals	
EMI	FCC Part 15, CISPR (EN55022) class A
EMS	EN61000-4-2 (ESD), EN61000-4-3 (RS), EN61000-4-4 (EFT), EN61000-4-5 (Surge), EN61000-4-6 (CS), EN61000-4-8, EN61000-4-11
Shock	IEC60068-2-27
Free Fall	IEC60068-2-32
Vibration	IEC60068-2-6
Safety	EN60950-1
Warranty	5 years

Ordering Information

ISC- **A B C D E**

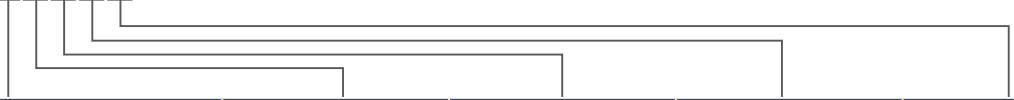

Code Definition	Serial Port Number	Port Type	Converter Prot Number	Converter Type	Other Type
Option	- 4 : 4port - 8 : 8port	- 1 : RS-232 only - 2 : RS-422/485 - 3 : RS-232/422/485	- 1 : 1port	- 0 : other type - 1 : RS-232 only - 2 : RS-422/485 - 3 : RS-232/422/485	- F : 100Base-FX Fiber - U : USB

	Model Name	Description
Available Model	ISC-4110U_US	Industrial 1-port USB to 4-port RS-232 serial media converter, US power adapter
	ISC-4110U_EU	Industrial 1-port USB to 4-port RS-232 serial media converter, EU power adapter
	ISC-8110U_US	Industrial 1-port USB to 8-port RS-232 serial media converter, US power adapter
	ISC-8110U_EU	Industrial 1-port USB to 8-port RS-232 serial media converter, EU power adapter

Packing List <ul style="list-style-type: none"> ISC-4110U/8110U DIN-Rail Kit Wall-Mount Kit USB Cable DB62 to DB9 Cable 12V/1A Power adapter ORing Tool CD Quick Installation Guide 	Optional Accessories (Can be purchased separately) <ul style="list-style-type: none"> DR-45 series, 45W DIN-Rail power supply DR-75 series, 75W DIN-Rail power supply DR-120 series, 120W DIN-Rail power supply SDR-240-48, 240W DIN-Rail power supply SDR-480-48, 480W DIN-Rail power supply FPC series : Fiber Patch cord
--	--